

T5-1C/2C/3C/4C-120(EN)



Smart Touch Wall Switch

User Manual V1.0

Introduction

SONOFF TX Ultimate is a smart touch wall switch with LED lights which will produce sound, light and vibration effects when it is turned on/off. After adding in the eWeLink App, you can remote control on/off, switch the ambient lighting modes, set timer and smart scene on the phone.



Remote Control



Voice Control



Smart Scene



Ambient Lighting Mode



Touch Vibration



Light Effects

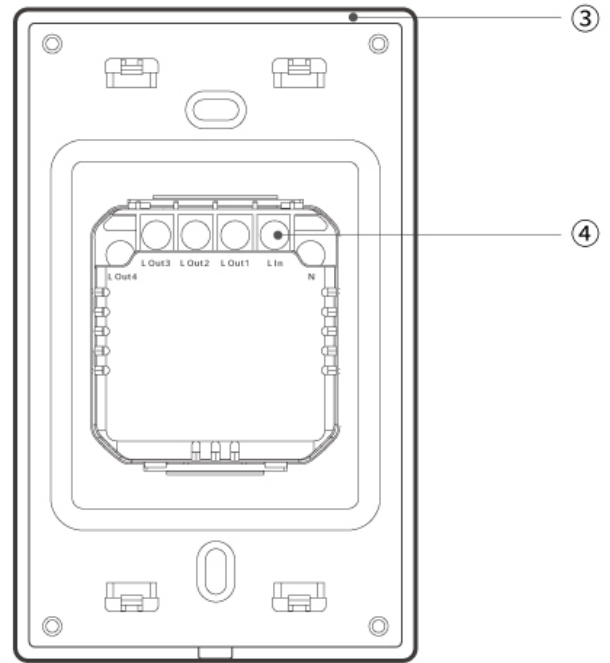
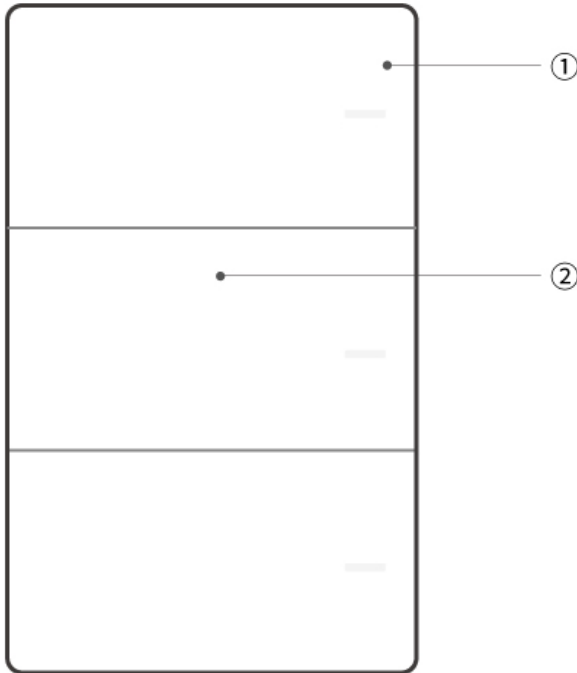

① Switch panel	② Touch control screen	③ Ambient light/Switches LED indicator/Network LED indicator	④ Wiring ports
----------------	------------------------	--	----------------

LED Indicator status and instructions

LED indicators	LED indicator status	Instructions
Pairing LED indicator	In the “Cycle mode”	Device is in pairing mode
Network LED indicator	Flashes blue quickly once	Device is not connected to router

	Flashes blue quickly twice	Device is connected to the router but not to the cloud
--	----------------------------	--

Operation instruction

1. Horizontal installation

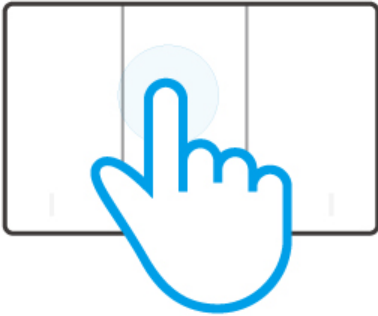

Quick click

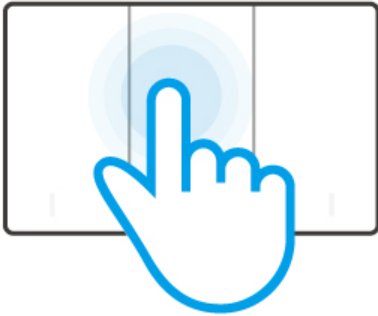

Long press

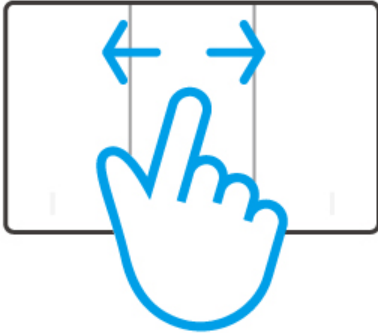

Swipe

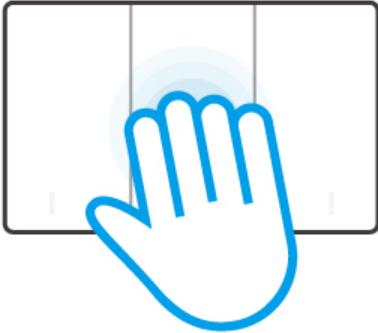

Multi-point click

2. Vertical installation

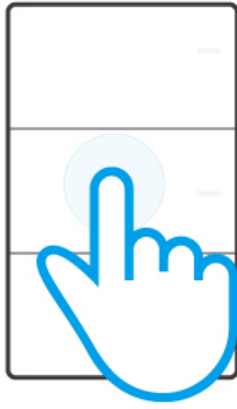

Quick click

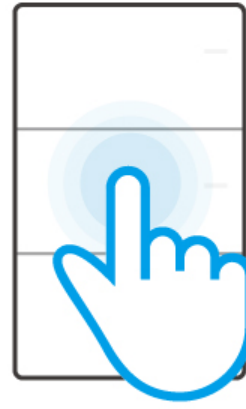

Long press

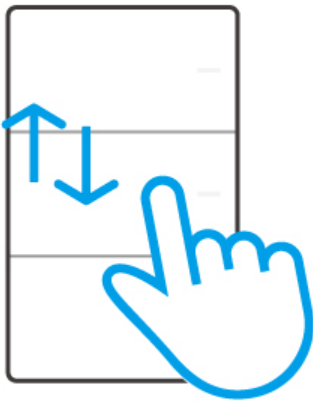

Swipe

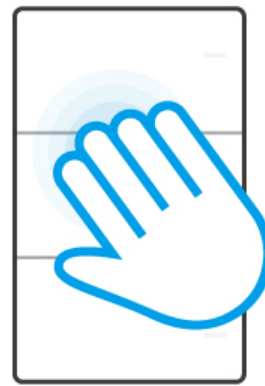

Multi-point click

Operations	Instructions	Functions
Quick click	Click the switch panel quickly	Turn on/off the switches and trigger the smart scenes
Long press	Long press the switch panel for 5s	Make the device enter the pairing mode
Swipe	Swipe on the switch panel and ensure the swipe distance exceeds 50% of it <ul style="list-style-type: none"> • T5-120 supports left/right swipe • T5-120 supports up/down swipe 	Trigger the smart scene

Multi-point click	Multiple fingers click the switch panel	Turn on/off the ambient light manually
-------------------	---	--

Specifications

Model	T5-1C-120/T5-2C-120/T5-3C-120/T5-4C-120
MCU	ESP32
Input	1C:100-240V ~ 50/60Hz Max 5A 2C:100-240V ~ 50/60Hz Max 10A 3C:100-240V ~ 50/60Hz Max 15A 4C:100-240V ~ 50/60Hz Max 16A
Output	1C:100-240V ~ 50/60Hz Max 5A 2C:100-240V ~ 50/60Hz Max 5A/Gang 10A/Total 3C:100-240V ~ 50/60Hz Max 5A/Gang 15A/Total 4C:100-240V ~ 50/60Hz Max 4A/Gang 16A/Total
LED load	1C: 150W Max@240V, 75W Max@100V 2C: 150W Max@240V/Gang, 75W Max@100V/Gang 3C: 150W Max@240V/Gang, 75W Max@100V/Gang 4C: 150W Max@240V/Gang, 75W Max@100V/Gang
Wireless connection	IEEE 802.11b/g/n 2.4GHz
Net weight	1C(196.6g), 2C(202g), 3C(207.6g), 4C(210g)
Product dimension	120x74x39mm
Colour	White
Casing materials	PC +CRS
Applicable place	Indoor
Working temperature	-10°C ~ 40°C

Working humidity	5~95%RH, non-condensing
Certification	CE/FCC/RoHS/ISED
Executive standard	EN IEC 60669-2-1

Installation

1. Power off

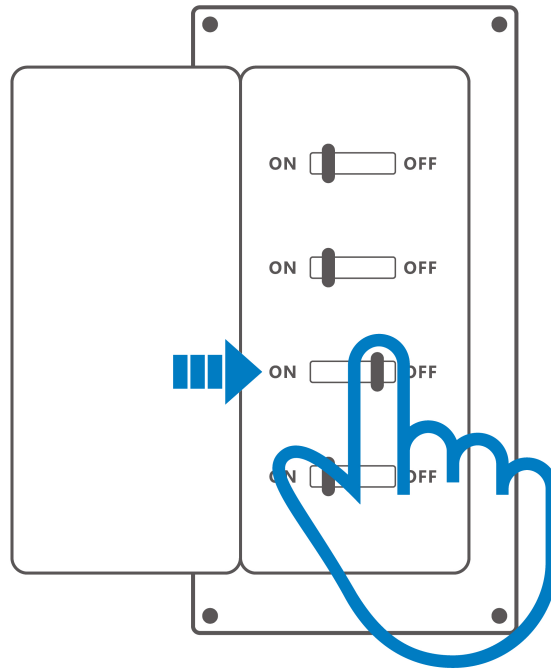

*Please install and maintain the device by a professional electrician. To avoid electric shock hazard, do not operate any connection or contact the terminal connector while the device is powered on!

2. Wiring instruction

- Switch mode

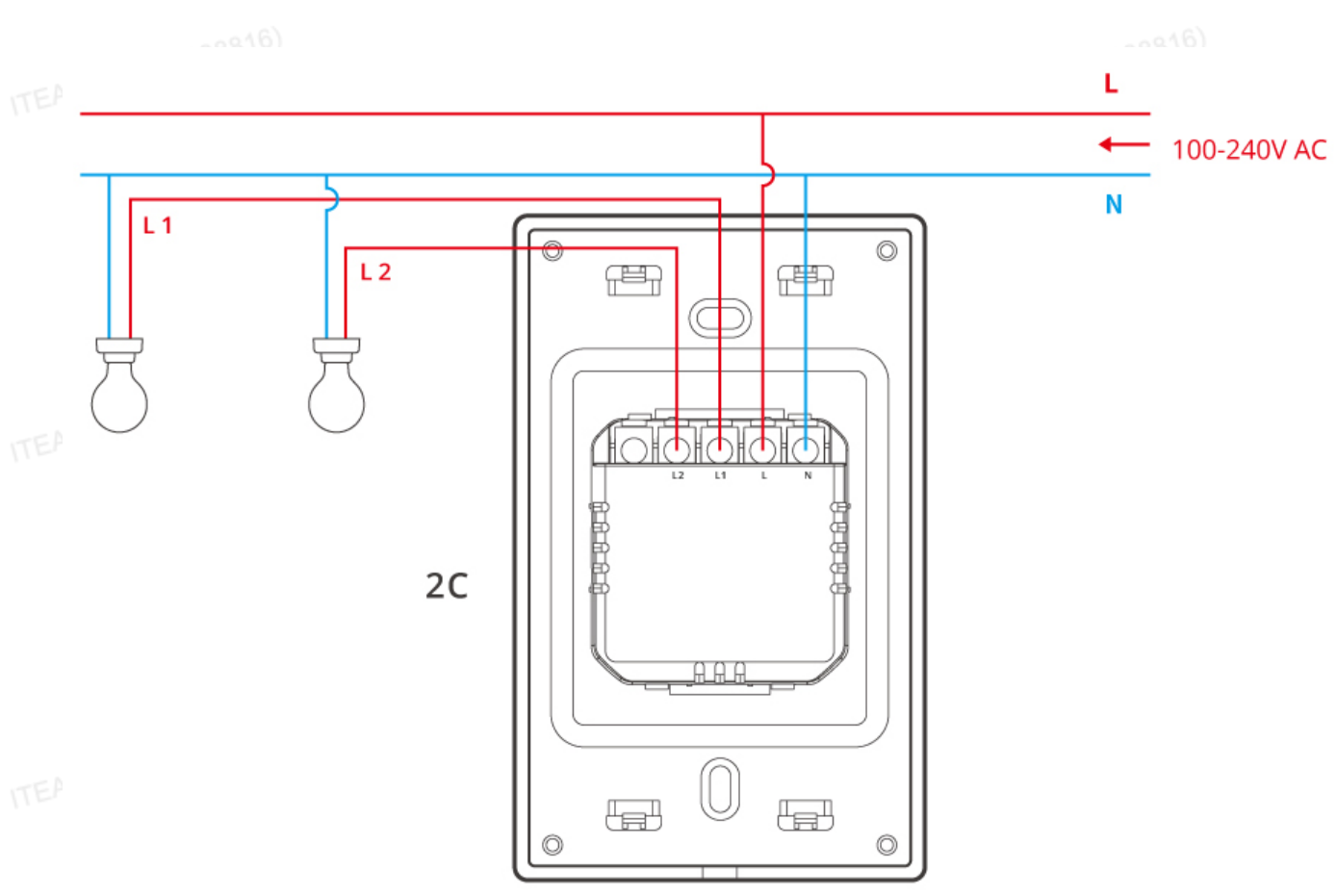
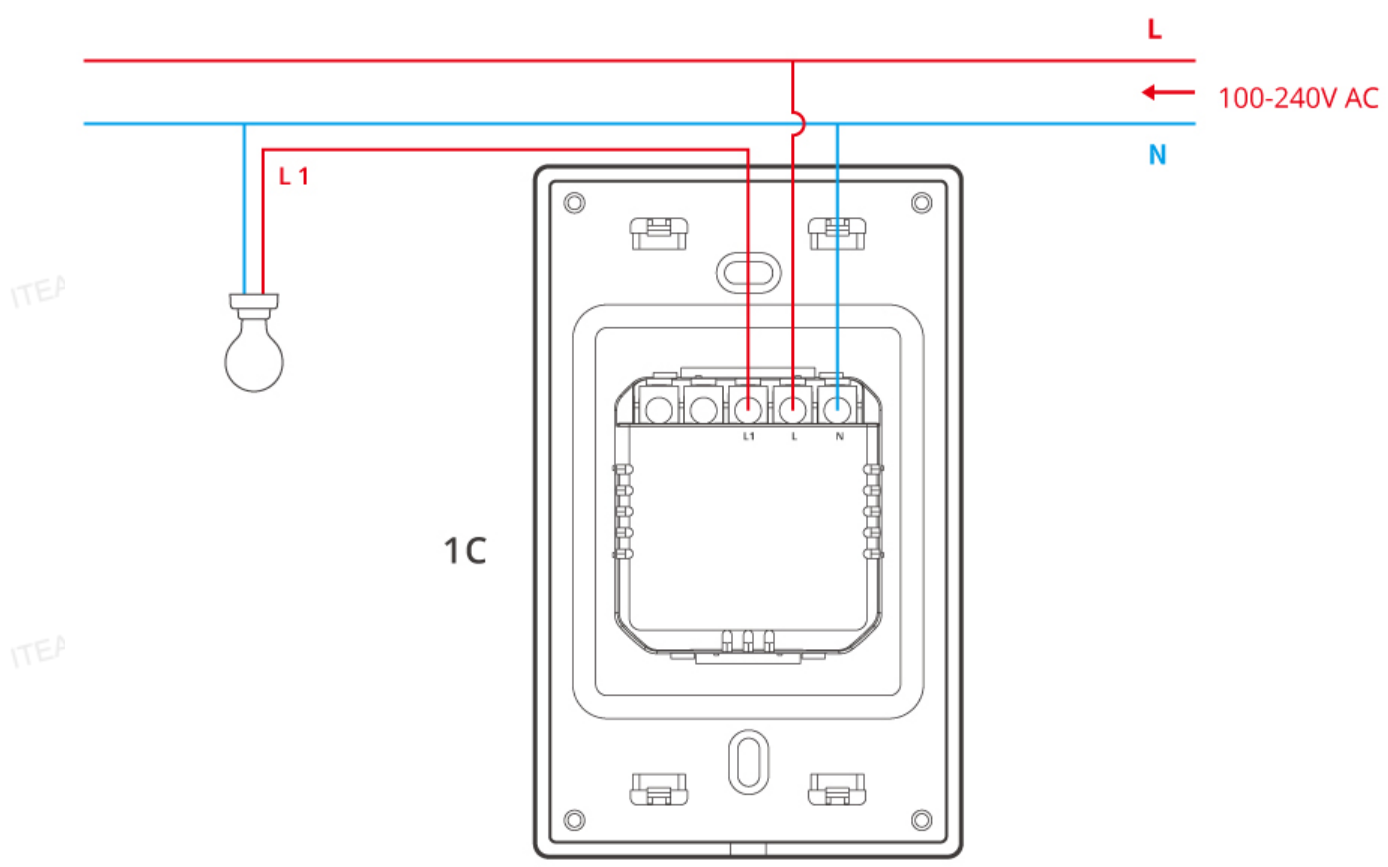

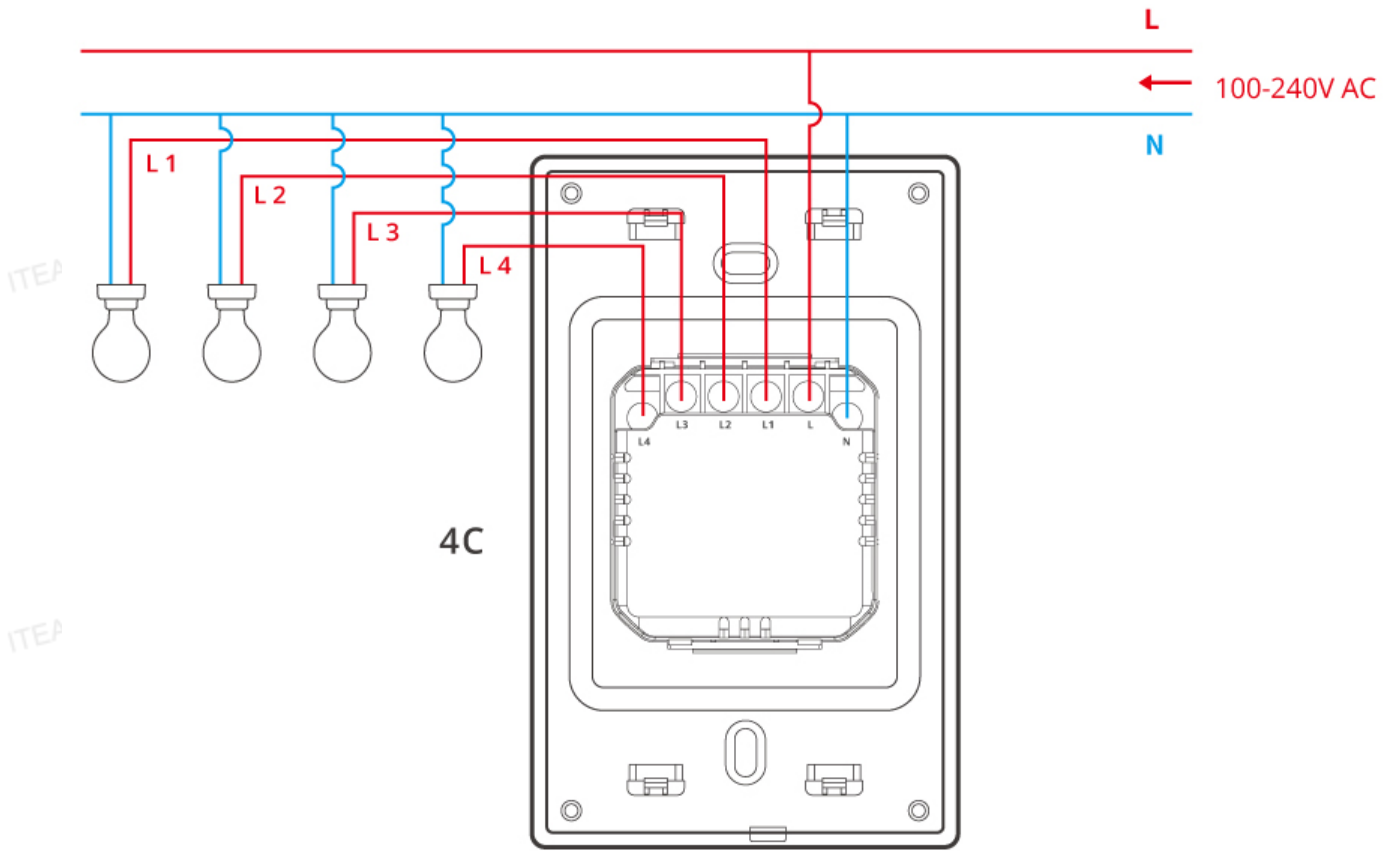
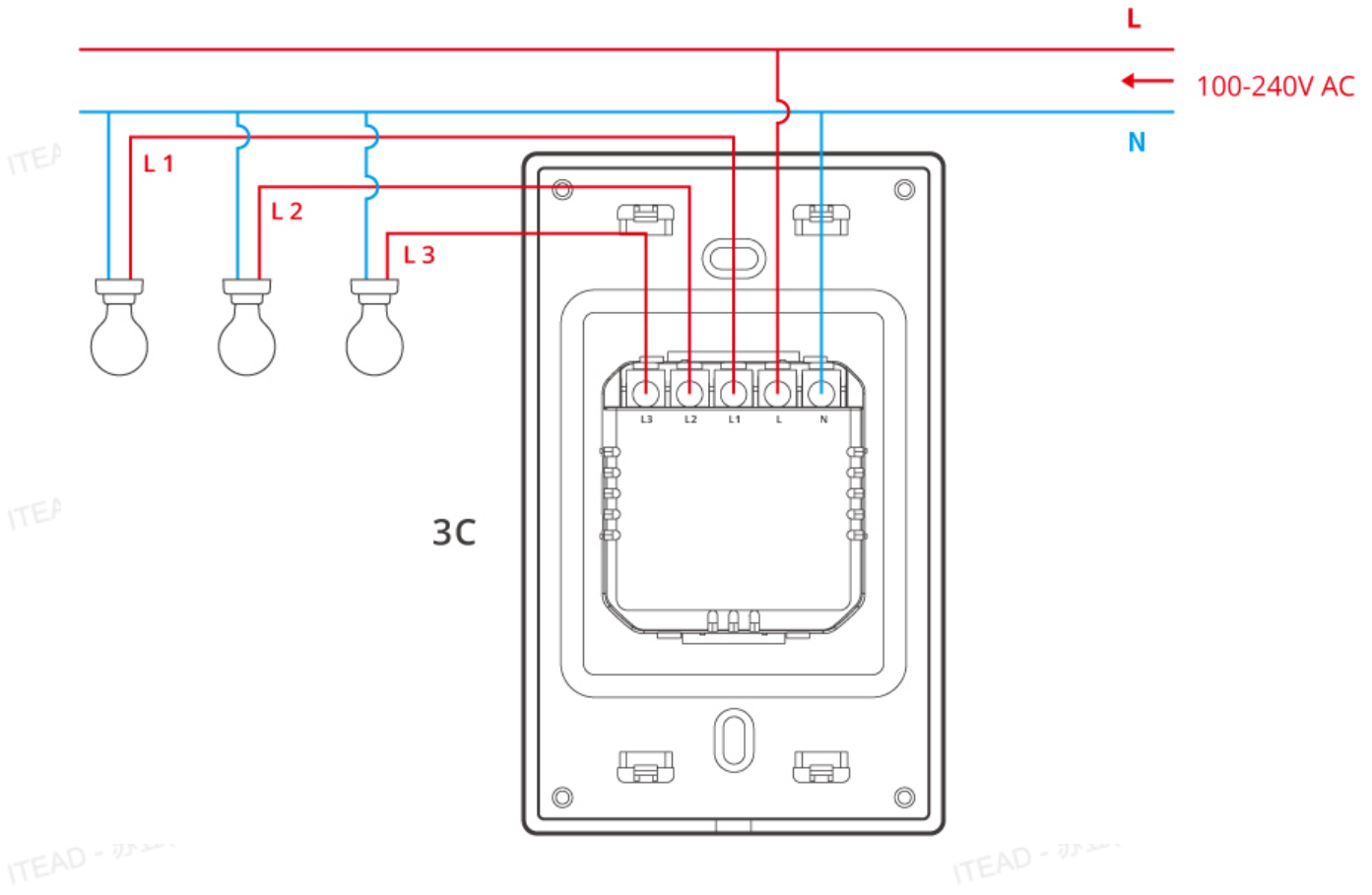

*To ensure the safety of your electrical installation, it's essential either a Miniature Circuit Breaker (MCB) or a Residual Current operated Circuit-breaker with Integral Overcurrent protection(RCBO) with an electrical rating of 10A (T5-1C-120, T5-2C-120), 16A (T5-3C-120, T5-4C-120) has been installed before the TX Ultimate. (Not include motor load)

*Make sure all wires are connected correctly.

- **Motor mode**

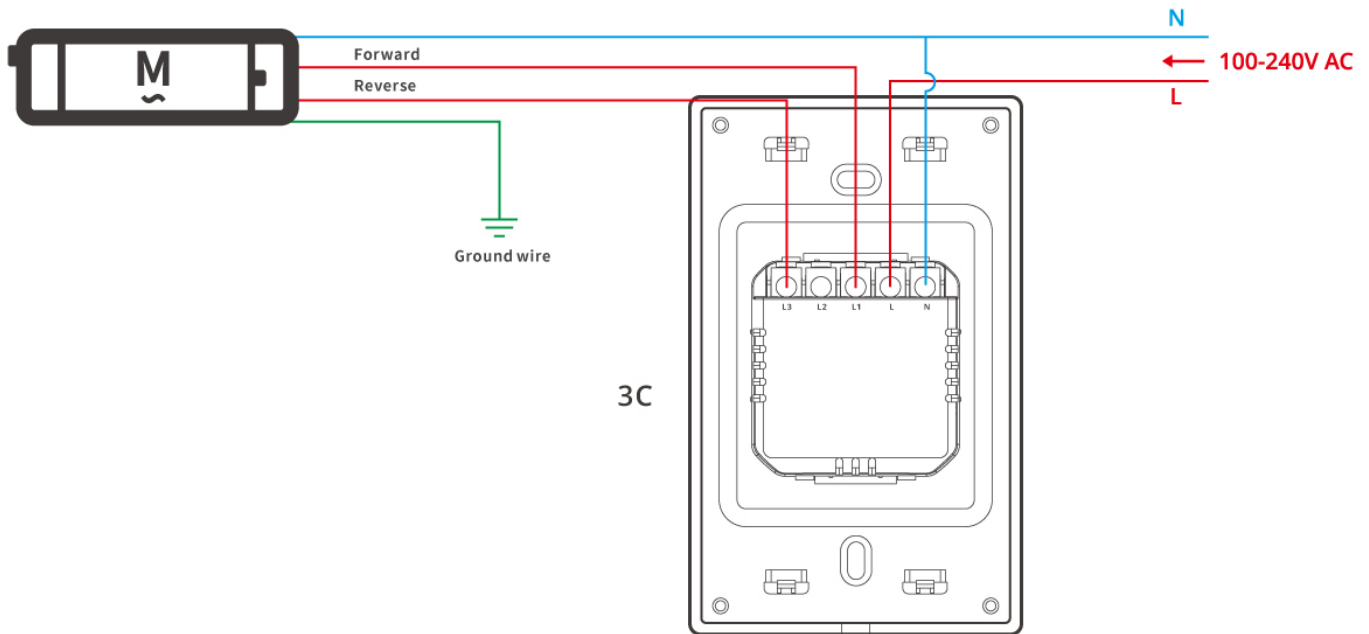

*Only T5-3C-120 supports switching to motor mode.

3. Power on

After powering on, the device will enter the Bluetooth pairing mode by default during the first use and the LED frame light will light in the “Cycle mode.”



**The device will exit the Bluetooth pairing mode when it doesn't be paired successfully within 30mins. If you want to access the pairing mode again, touch the wall switch panel for 5s until the LED frame lights in the "Cycle mode".*

Add device

eWeLink App Pairing

1.Download the“eWeLink”App

Please download the "eWeLink" App from Google Play Store or Apple App Store.

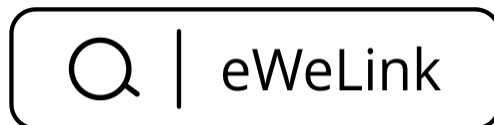

2.Add device



Enter "Scan "

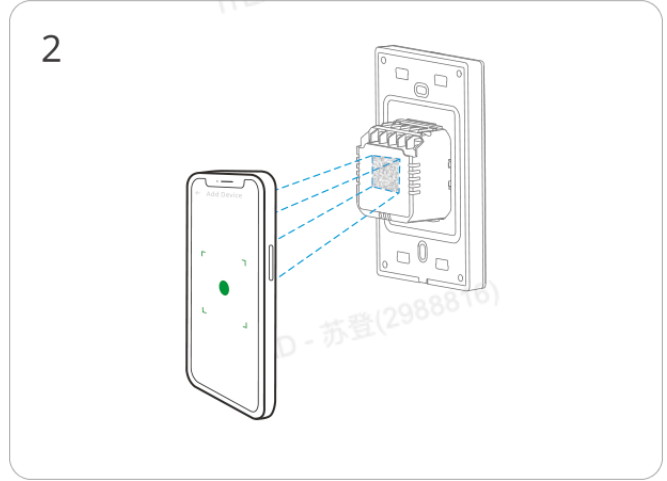

Scan the QR code on the device

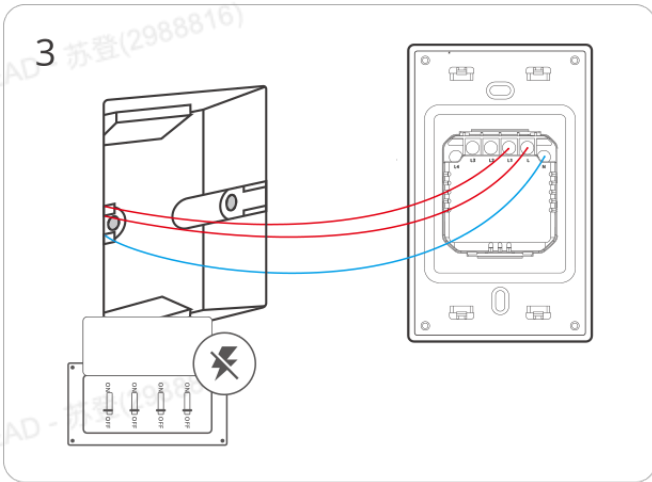

Please follow the wiring instructions to connect the wires (ensure power is disconnected in advance and consult an electrician if needed)

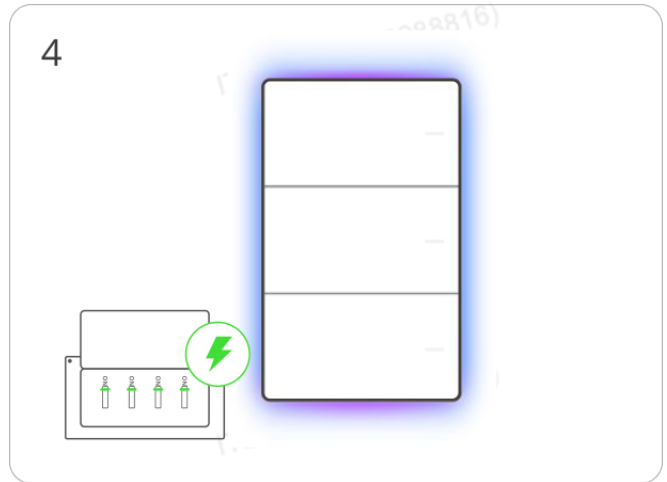

Power on the device

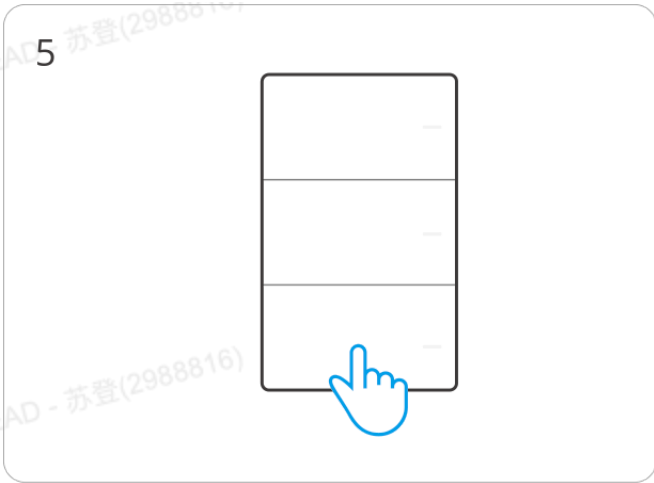

Long press the button for 5 seconds

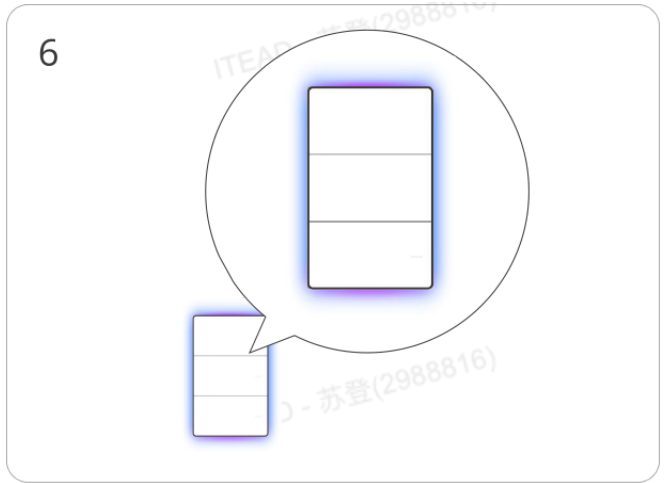

Check Wi-Fi LED indicator flashing status
(Cycle mode.)



Select "Add Device"

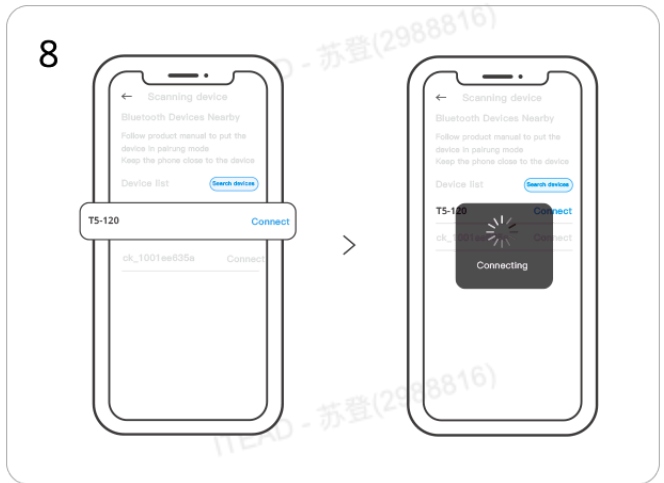

Search for the device and start connecting

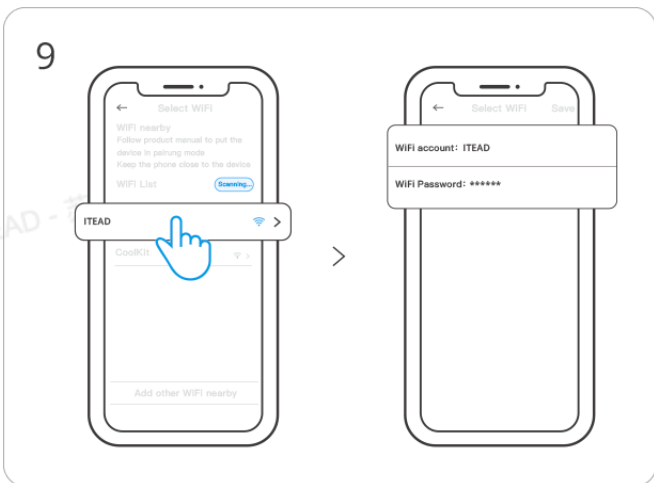

Select the "Wi-Fi" network and
enter the password.

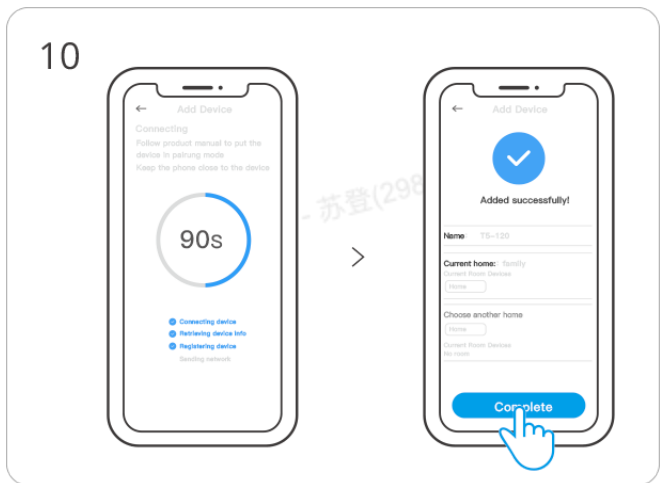

Device "Added completely".

Motor mode

After wiring based on Motor mode, you can switch the Working mode to Motor mode in the App, making traditional motors smart and controllable through methods such as smartphones, smart scenes, and voice commands.

1. Applicable load: Can control bidirectional AC motors, such as roller shutters, blinds, curtains, and awnings;
 - Only supports motors with limited position functions.
 - Maximum motor load current: 1A
2. Working methods:
 - Connect the positive rotation line to channel one to control positive rotation/opening.
 - Connect the reverse rotation line to channel three to control reverse rotation/closing.
3. App settings: After adding the device, switch the Working mode to Motor mode following the steps in the figures.

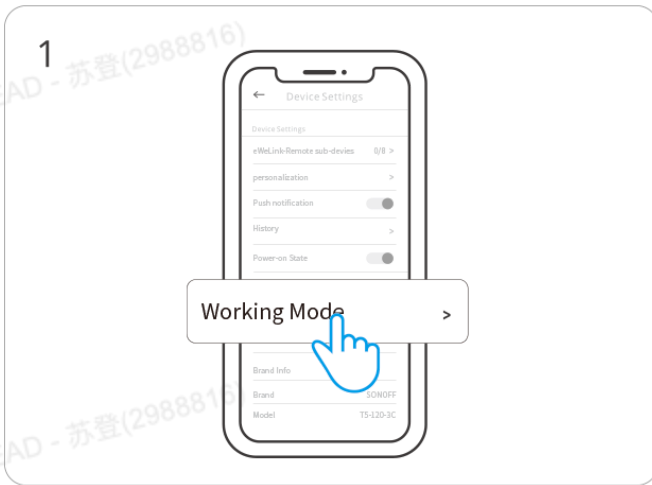

Select “Working Mode” on the Device Settings page.

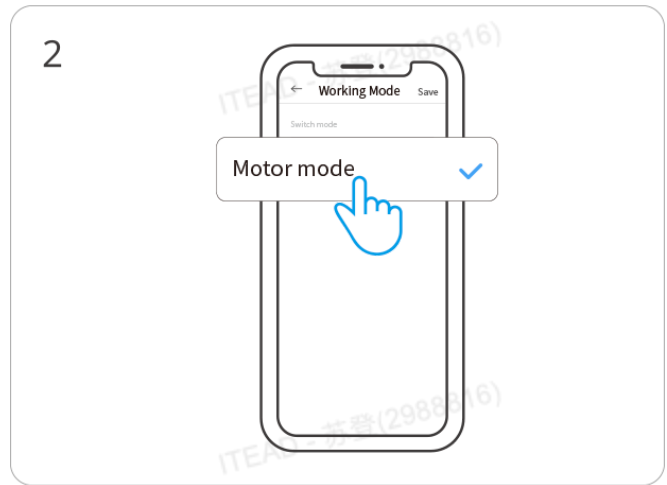

Select “Motor Mode” .

Add eWeLink-Remote-devices

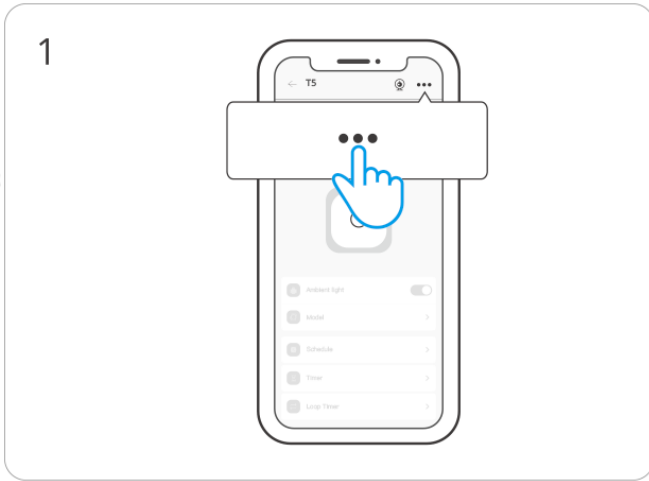

Click “...” on the homepage of T5

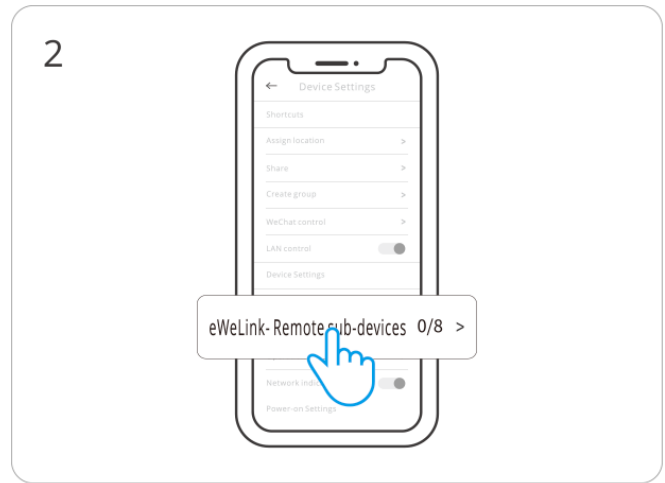

Click “eWeLink-Remote sub-devices” in the Device Settings



Click “Add” button, and eWeLink-Remote gateway will enter the learning mode

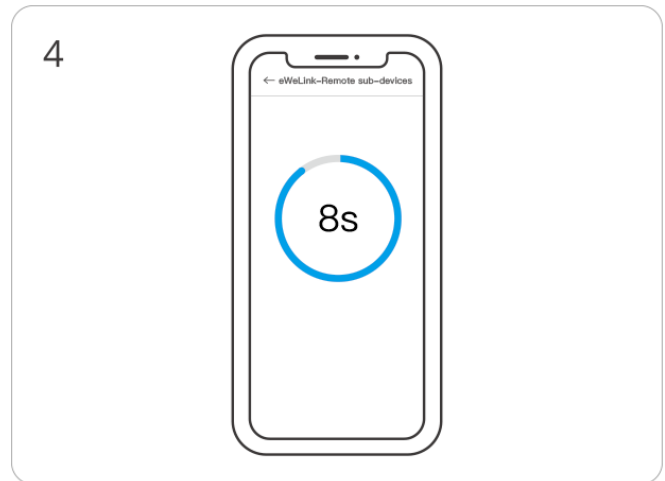

Click the sub-device button within 10 seconds

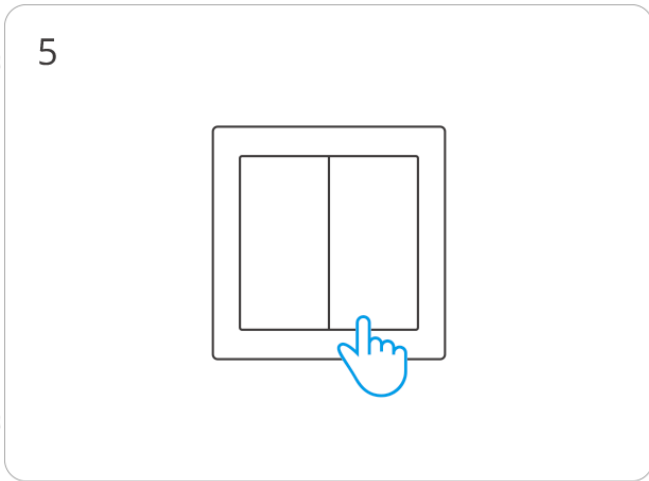

Click the button on the sub-device to add the device

Device Factory Reset

- After "Delete the Device" in the eWeLink App
- For devices previously successfully added to eWeLink, perform a new pairing using a different eWeLink account

FCC compliance statement

1.This device complies with part 15 of the FCC Rules. Operation is subject to the following two conditions:

- (1) This device may not cause harmful interference, and
- (2) This device must accept any interference received, including interference that may cause undesired operation.

2.Changes or modifications not expressly approved by the party responsible for compliance could void the user's authority to operate the equipment.

Note: This equipment has been tested and found to comply with the limits for a Class B digital device, pursuant to part 15 of the FCC Rules. These limits are designed to provide reasonable protection against harmful interference in a residential installation. This equipment generates,

uses and can radiate radio frequency energy and, if not installed and used in accordance with the instructions, may cause harmful interference to radio communications. However, there is no guarantee that interference will not occur in a particular installation. If this equipment does cause harmful interference to radio or television reception, which can be determined by turning the equipment off and on, the user is encouraged to try to correct the interference by one or more of the following measures:

- Reorient or relocate the receiving antenna.
- Increase the separation between the equipment and receiver.
- Connect the equipment into an outlet on a circuit different from that to which the receiver is connected.
- Consult the dealer or an experienced radio/TV technician for help.

FCC Radiation Exposure statement:

This equipment complies with FCC radiation exposure limits set forth for an uncontrolled environment.

This equipment should be installed and operated with minimum distance of 20 cm between the radiator and your body.

This transmitter must not be co-located or operating in conjunction with any other antenna or transmitter.

ISED Notice

This device contains licence-exempt transmitter(s)/receiver(s) that comply with Innovation, Science and Economic Development Canada's licence-exempt RSS(s). Operation is subject to the following two conditions:

- (1) This device may not cause interference.
- (2) This device must accept any interference, including interference that may cause undesired operation of the device.

This Class B digital apparatus complies with Canadian ICES-003(B).

This device complies with RSS-247 of Industry Canada. Operation is subject to the condition that this device does not cause harmful interference.

L'émetteur/récepteur exempt de licence contenu dans le présent appareil est conforme aux CNR d'Innovation, Sciences et Développement économique Canada applicables aux appareils radio exempts de licence. L'exploitation est autorisée aux deux conditions suivantes :

- (1) L'appareil ne doit pas produire de brouillage;
- (2) L'appareil doit accepter tout brouillage radioélectrique subi, même si le brouillage est susceptible d'en compromettre le fonctionnement.

Cet appareil numérique de la Classe B conforme à la norme NMB-003(B) du Canada.

Cet appareil est conforme à la norme RSS - 247 d'Industrie Canada. Le fonctionnement est soumis à la condition que cet appareil ne provoque pas d'interférences nuisibles.

ISED Radiation Exposure Statement

This equipment complies with ISED radiation exposure limits set forth for an uncontrolled environment.

This equipment should be installed and operated with minimum distance of 20 cm between the radiator and your body.

This transmitter must not be co-located or operating in conjunction with any other antenna or transmitter.

Cet équipement est conforme aux limites d'exposition aux rayonnements de la ISED établies pour un environnement non contrôlé.

Cet équipement doit être installé et fonctionner à au moins 20cm de distance d'un radiateur ou de votre corps.

Cet émetteur ne doit pas être co-localisé ou fonctionner en conjonction avec une autre antenne ou un autre émetteur.

SAR Warning

Under normal use of condition, this equipment should be kept a separation distance of at least 20 cm between the antenna and the body of the user.

Dans des conditions normales d'utilisation, cet équipement doit être maintenu à une distance d'au moins 20 cm entre l'antenne et le corps de l'utilisateur.

WEEE Warning



WEEE Disposal and Recycling Information All products bearing this symbol are waste electrical and electronic equipment (WEEE as in directive 2012/19/EU) which should not be mixed with unsorted householdwaste. Instead, you should protect human health and the environment by handingover your waste equipment to a designated collection point for the recycling of waste electricaland electronic equipment, appointed by the government or local authorities. Correct disposaland recycling will help prevent potential negative consequences to the environment and human health. Please contact the installer or local authorities for more information about thelocation as well as terms and conditions of such collection points.

EU Declaration of Conformity

Hereby, Shenzhen Sonoff Technologies Co., Ltd declares that the radio equipment type [T5-1C-120, T5-2C-120, T5-3C-120, T5-4C-120] is in compliance with Directive 2014/53/EU. The full text of the EU declaration of conformity is available at the following internet address:

<https://sonoff.tech/compliance/>

Scatola	Scatola	Manuale	Pellicola	Borsa
PAP 20	PAP 21	PAP 22	PET 1	LDPE 4
Carta	Carta	Carta	Plastica	Plastica
RACCOLTA DIFFERENZIATA				
Verifica le disposizioni del tuo Comune. Separa le componenti e conferiscile in modo corretto.				

EU Operation frequency Range:

Wi-Fi:

802.11 b/g/n20: 2412–2472MHz

802.11 n40: 2422–2462MHz

BLE:2402–2480MHz

EU Output Power:

Wi-Fi 2.4G \leq 20dBm

BLE \leq 10dBm

The logo for Sonoff, featuring a stylized 'S' with three curved lines above it representing a signal or Wi-Fi, followed by the word 'SONOFF' in a bold, black, sans-serif font.

Manufacturer: Shenzhen Sonoff Technologies Co., Ltd.

Address: 3F & 6F, Bldg A, No. 663, Bulong Rd, Shenzhen, Guangdong, China

ZIP code: 518000

Service email: support@itead.cc

Website: sonoff.tech

Made in China



Points de collecte sur www.quefairedemesdechets.fr
Privilégiez la réparation ou le don de votre appareil !

