



KEPLER
electronics

Ceiling Mount DALI-2 PIR Sensor + Light Sensor



Important: Read All Instructions Prior to Installation

Function introduction



Motion sensor indicator (Red) : flashes once when motion is being detected. Stays off when no motion is being detected.

DALI signal indicator (Green) : flashes when receives DALI signal from application controller and reports event messages to application controller.

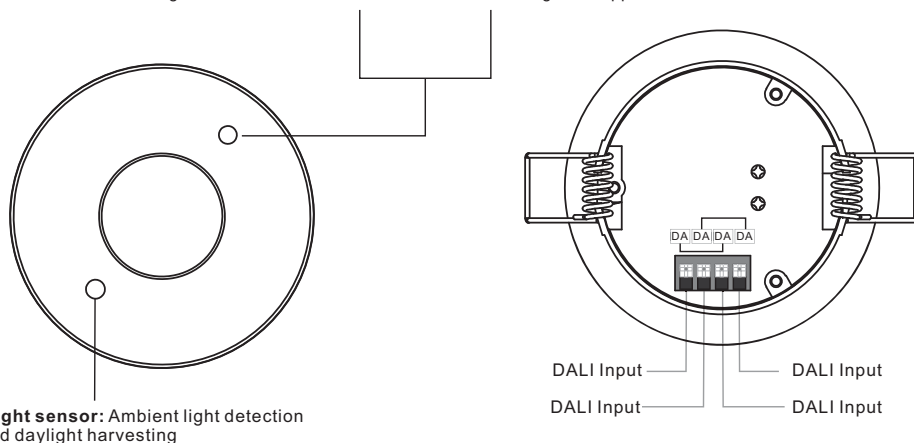

Product Description

The ceiling mount multi-sensor is DALI-2 device which combines motion sensor and light sensor. The device performs motion detection and measures illuminance level. The DALI-2 multi-sensor can work with D4i LED drivers or luminaires, the luminaires just need to be connected to mains power. The result is increased occupant comfort and significant energy savings that meet the most demanding building energy codes. The sensor is suitable for low bay applications which need sensor based automation.

The multi-sensor can be powered by DALI bus and no extra power supply required, which means easier and faster wiring and installation process.

Commissioning

The multi-sensor is a DALI-2 device as defined in the IEC 62386 (2014) standard and can be integrated into DALI-2 systems of other vendors. It is easily configurable through a DALI-2 compliant central control unit.

The DALI-2 multi-sensor supports 2 instances standardized according to DALI: motion detector instance (303) for motion detection and light sensor instance (304) for light measurement. The multi-sensor is designed to be used in conjunction with a DALI-2 compliant central control unit. Each instance can be configured individually.

Product Data

Physical Information

Dimensions / Weight	See dimensions
Cutting Hole	70-73mm
Material / Color	ABS / White
Wire Gauge	26-16 AWG (0.2-1.3 mm ²)
Strip Length	0.28-0.35 in. / 7-9 mm

Electrical Information

Power Supply	DALI Bus
Max. DALI Current Draw	6mA
Control	DALI
Marking Terminals	DA, DA
Motion Detection Indicator	Red (motion detection)
DALI Indicator	Green (DALI)

Sensing

Motion Detection (62386 - 303)	PIR sensor
Light Sensor (62386 - 304)	Event: 0-1000 Lux (10bit), resolution: 10lux
Mounting Height	recommended height: 8ft (2.5m)
Detection Angle	130°
Function	Configurable

Environment

Operating Temperature Range	32°F to 104°F / 0°C to 40°C (indoor use only)
Operating Humidity	0-95% (non condensing)
Safety Certification	cULus Listed, CE

Key Features

- PIR motion detection
- Motion sensor instance type 3 (303)
- Illuminance measurement
- Light sensor instance type 4 (304)
- Autonomous sensor-based control
- Ceiling recessed installation

Benefits

- Cost-effective solution for energy savings
- Energy code compliance
- Compatible with universal DALI-2 compliant central control unit that supports sensor input devices

Applications

- Open offices
- Individual offices
- Conference rooms
- Classrooms
- Retail stores
- Hospitals
- Lobbies
- Photo Controls
- Central Management System

Safety & Warnings

- DO NOT install with power applied to device.
- DO NOT expose the device to moisture.

Application & Function

Instances

The DALI-2 multi-sensor supports 2 instances standardized according to DALI: occupancy sensor instance (303) for motion detection and light sensor instance (304) for light measurement.

- Instance number 0: instance type is Occupancy sensor
- Instance number 1: instance type is Light sensor

Instances-General

Each instance can be configured individually. Some settings have the same functionality for all sensor instances and are therefore described in this section. Instance specific settings are explained for each individual instances in the following respective sections.

Enable/Disable

If instances are not required, they can be deactivated. In this case, event messages are not sent, and the measured values are not updated. They can, however, still be queried via a "Query" command, and the DALI-2 configuration commands and queries are still supported.

Event Scheme

The event scheme determines which information is transferred with the event. This information is required, to enable recognition and / filtering of events on the bus. The following 5 options are available:

- **Instance addressing:** instance type and instance number
- **Device Addressing:** device address and instance type
- **Device/Instance Addressing:** device address and instance number
- **Device Group Addressing:** device group and instance type
- **Instance Group Addressing:** instance group and instance type

Instance group: up to three instance groups can be assigned for each instance. Only the "Primary Group" is used for the event.

Instance type: the instance type defines which DALI-2 standard is valid for this instance. (The different instance types are specified in the DALI-2 standard.)

Instance number: each instance in a device has a unique instance number.

Device group: The device can be assigned to up to 32 device groups (0...31). The lowest device group is used for the event.

Device address: a device address (or short address) (0..63) can be assigned to each device. With this the device can be clearly addressed. (Identical short addresses should be avoided.)

Event Priority

The event priority determines the order in which events are sent when they occur simultaneously on the bus. Priority 2 = highest and 5 = lowest.

Dead Time

The dead time can be set for each instance. It determines the time that must pass before an event can be sent again. This also applies if the event information (measured value) changes. If no dead time is required, it can be deactivated.

Report Time

If the event information does not change, the event is sent cyclically with the report time. The report time can be set for each instance. It determines the maximum time between a sent event and re-sending.

Hysteresis

Not every change in value leads to an event being generated. The hysteresis can be used to set which percentage change is necessary to trigger a new transmission. Attention, the hysteresis band is not arranged symmetrically. The following applies:

Increasing value

The condition for an event is only fulfilled if the next value falls below the previous value minus the hysteresis or if the next value is greater than the previous value.

Decreasing value

the condition for an event is only fulfilled if the next value exceeds the previous value plus the hysteresis or the next value is smaller than the previous value.

Hysteresis Min

Hysteresis Min is the minimal hysteresis value that cannot be fallen below of.

Instance 0 – Occupancy Sensor

Instance 0 is an instance standardized by DALI-2 (62386-303), for sensors that detect motion. All settings are implemented according to the standard. The instance is DALI-2 certified.

The sensor switches between the following states:

- People in the room and movement (0xFF)
- People in the room and no movement (0xAA)
- Empty room (0x00)

If the sensor detects movement, it immediately changes to the state: "people in the room and movement". This state is exited after 1 second at the earliest if no further movement is detected. In this case it changes to the state "People in the room and no movement". After the hold time has expired it changes to the state "Empty room"- Vacant.

Hold Time: hold time is the time that must pass before the state "people in the room and no movement" is changed to the state "empty room". If movement is detected during this time the state is changed back to: "People in the room and movement". (min. 1 second)

Query Input Value: The current sensor state can be queried using this DALI command. The following values are possible: 0x00, 0xAA, 0xFF (see paragraph above for the possible states)

Event: the sensor status is transmitted by events. The following event information is available:

Event name	Event Information	Description
No movement	00 0000 ---0b	No movement detected. Corresponding trigger is the 'No movement' trigger.
Movement	00 0000 ---1b	Movement detected. Corresponding trigger is the 'Movement' trigger.
Vacant	00 0000 -00-b	The area has become vacant. Corresponding trigger is the 'Vacant' trigger.
Still vacant	00 0000 -10-b	The area is still vacant. The event occurs at regular intervals as long as the vacant condition holds. Corresponding trigger is the 'Repeat' trigger.
Occupied	00 0000 -01-b	The area has become occupied. Corresponding trigger is the 'Occupied' trigger.
Still occupied	00 0000 -11-b	The area is still occupied. The event occurs at regular intervals as long as the occupied condition holds. Corresponding trigger is the 'Repeat' trigger.
Movement sensor	00 0000 1---b	The current event is triggered by a movement based sensor.
	1x xxxx xxxxb	Reserved.
	01 xxxx xxxxb	
	00 1xxx xxxxb	
	00 01xx xxxxb	
	00 001x xxxxb	
	00 0001 xxxxb	

For more details please refer to the standard IEC62386-303.

Event filter: The event filter defines for which status change an event is generated.

Filter arrangement:

- Bit0: Occupied Event active
- Bit1: Vacant Event active
- Bit2: Still Vacant/Occupied Event active
- Bit3: Movement Event active
- Bit4: No Movement Event active
- Bit5..Bit7: unused

Report Time: report time can only be set if the event filter "Repeat" is activated and the events: "Still Vacant" and "Still Occupied" are enabled. The time between sending a "Still-Event" again is determined by the Report Time.

Configuring Instance 0 – Occupancy Sensor

1. Set filter (SET EVENT FILTER): 1 Byte, corresponding relationship of each BIT and default value are as follows:

Bit	Description	Value	Default
0	Occupied event enabled?	"1" = "Yes"	1
1	Vacant event enabled?	"1" = "Yes"	1
2	Repeat event enabled?	"1" = "Yes"	0
3	Movement event enabled?	"1" = "Yes"	0
4	No movement event enabled?	"1" = "Yes"	0
5	Reserved	0	0
6	Reserved	0	0
7	Reserved	0	0

This command value: 0x68

2. Set hold time (SET HOLD TIMER (DTR0))
1 Byte, (1---255), actual value: HOLD TIMER×10S
This command value: 0x21

3. Set report time (SET REPORT TIMER (DTR0))
1 Byte, (0---255), actual value: REPORT TIMER×1S
This command value: 0x22

4. Set dead time (SET DEADTIME TIMER (DTR0))
1 Byte, (0---255), actual value: DEADTIME TIMER×50MS
This command value: 0x23

5. Query sensor sensitivity (SET sensitivity (DTR0))
1 Byte, (0---100),
This command value: 0x2b

6. Query instance resolution (QUERY RESOLUTION)
The resolution of occupancy sensor input value is 2,
This command value: 0x81

7. Query current input value of instance (QUERY INPUT VALUE)
Input values of occupancy sensor (4 values: 0, 0x55, 0xaa, 0xff),
This command value: 0x8c

Instance 1 – Light Sensor

Instance 1 is an instance standardized by DALI-2 (62386-304). All settings are implemented according to the standard. The instance is DALI-2 certified.

The current light value (lux) is measured by the sensor and can either be queried using a "Query" command or can be automatically provided by the sensor using an event.

The measuring range is 0Lux ... 1000Lux. The resolution differs between queries and generated events. A query supports an event resolution of 10Lux (10Bit).

Hysteresis: For information on the hysteresis see section Instances -General: Hysteresis

Hysteresis Min: set in lux. For general information on the hysteresis min see section Instances – General: Hysteresis Min

Event Filter: The light instance generates only one event with 10-bit resolution (0... 1000 lux, step size 10lux). If the filter is deactivated, no events will be sent.

Event: the illuminance level is transmitted by event. The following event information is available:

Event name	Event Information	Description
illuminance level report	illuminanceEvent	An illuminance level report, passing the actual illuminance level along.

For more details please refer to the standard IEC62386-304.

Configuring Instance 1 – Light Sensor

1. Set filter (SET EVENT FILTER): 1 Byte, only 1 BIT used, corresponding relationship and default value are as follows:

Bit	Description	Value	Default
0	Illuminance level event enabled?	"1" = "Yes"	1
1	Reserved	0	0
2	Reserved	0	0
3	Reserved	0	0
4	Reserved	0	0
5	Reserved	0	0
6	Reserved	0	0
7	Reserved	0	0

This command value: 0x68

2. Set report time (SET REPORT TIMER (DTR0))
1 Byte, (0---255), actual value: REPORT TIMER×1S
This command value: 0x30

3. Set dead time (SET DEADTIME TIMER (DTR0))
1 Byte, (0---255), actual value: DEADTIME TIMER×50MS
This command value: 0x32

4. Set hysteresis (SET HYSTERESIS (DTR0))
1 Byte, (0---25%), actual value: HYSTERESIS ×current illuminance value
This command value: 0x31

5. Set hysteresis min (SET HYSTERESIS MIN (DTR0))
1 Byte, (0---255)
This command value: 0x33

6. Query instance resolution (QUERY RESOLUTION)
The resolution of illuminance is 10,
This command value: 0x81

7. Query instance current value (QUERY INPUT VALUE)
Current value of illuminance (0-1000),
This command value: 0x8c

8. Query instance current latch value (QUERY INPUT VALUE LATCH)
This command value: 0x8d

Configuration Interface

Events & Timer Configuration

启用

事件筛选	Timers
<input checked="" type="checkbox"/> Occupied	Report <input type="text" value="41:000"/> s
<input checked="" type="checkbox"/> Vacant	Deadtime <input type="text" value="1"/> s
<input checked="" type="checkbox"/> Repeat	Hold <input type="text" value="10:00"/> min
<input checked="" type="checkbox"/> Movement	Sensitivity <input type="text" value="2"/>
<input checked="" type="checkbox"/> NoMovement	

Report: this means report time, if the event information does not change, the event is sent cyclically with the report time. The report time can be set for each instance. It determines the maximum time between a sent event and re-sending.

Deadtime: this means dead time, the dead time can be set for each instance. It determines the time that must pass before an event can be sent again. This also applies if the event information (measured value) changes. If no dead time is required, it can be deactivated.

Hold: this means hold time, hold time is the time that must pass before the state "people in the room and no movement" is changed to the state "empty room". If movement is detected during this time the state is changed back to: "People in the room and movement".

Sensitivity: this means motion detection sensitivity, please ignore this parameter, since the sensitivity of PIR motion sensor can not be adjusted, this parameter is invalid.

Delay Time & Fade Time & Brightness Configuration

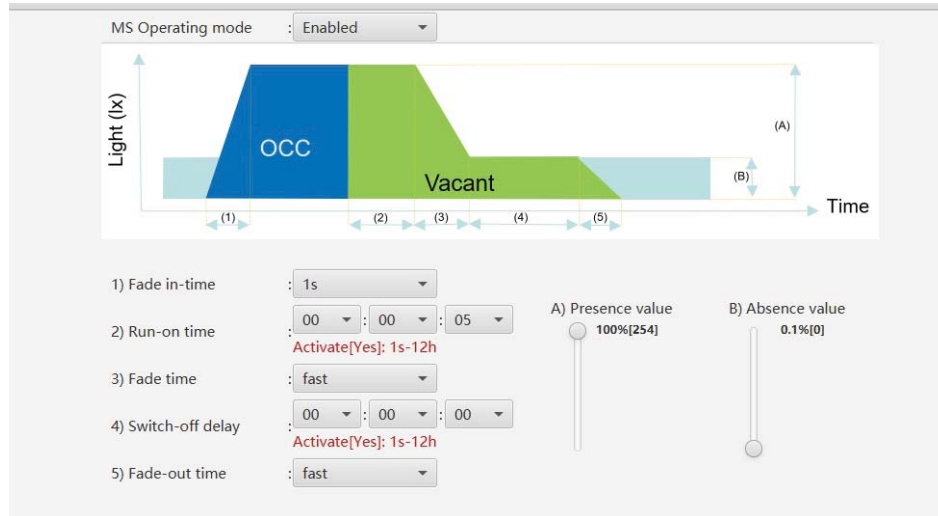

(1) Fade in time: this means the time that the destined DALI luminaires take to fade from current state to the configured state when the movement detected and the room is occupied.

OCC area: this area means "occupied and movement" (people in the room and movement) is triggered. Then report timer is re-triggered, during the report time, no movement detected, after report time expired, the "occupied and no movement" (people in the room and no movement) is triggered.

(2) Run on time: this means hold time, which will be triggered when "occupied and no movement" (people in the room and no movement) state is reported, only after the hold time expired, the state "vacancy" (empty room) can be triggered.

(3) Fade time: this means the time that the destined DALI luminaires take to fade from the configured state when the room is occupied to the configured state when the room is empty.

(4) Switch-off delay: this means how long the configured state of the destined DALI luminaires when the room is empty will last.

(5) Fade out time: this means the time that the destined DALI luminaires take to fade from the configured state when the room is empty to off state.

(A) Presence value: this means the configured state of destined DALI luminaires when the room is occupied (people in the room).

(B) Absence value: this means the configured state of destined DALI luminaires when the room is vacancy (no people in the room).

Detection Pattern

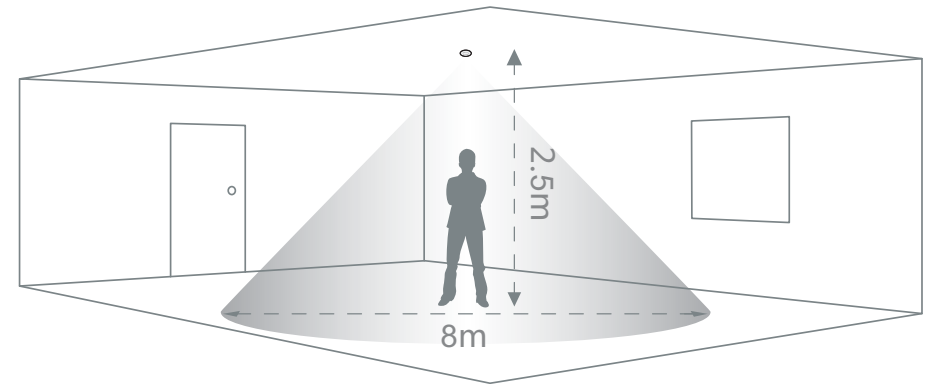

Coverage Side View

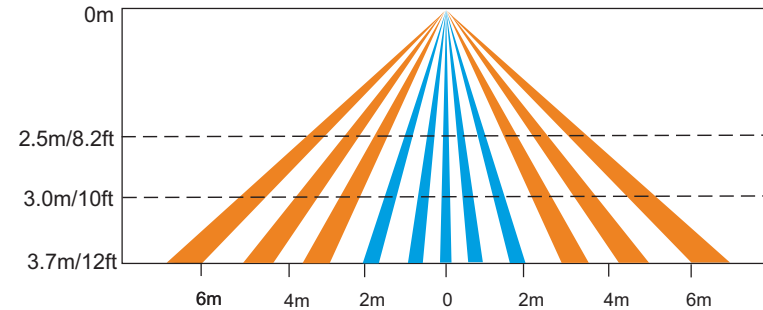

Coverage Top View

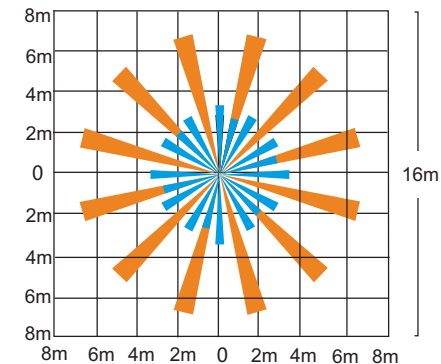

The detection area for movement sensor can be roughly divided into two parts:

- Slow movement (person moving < 1.0'/s or 0.3m/s)
- Quick movement (person moving > 1.3'/s or 0.4m/s)

Installation

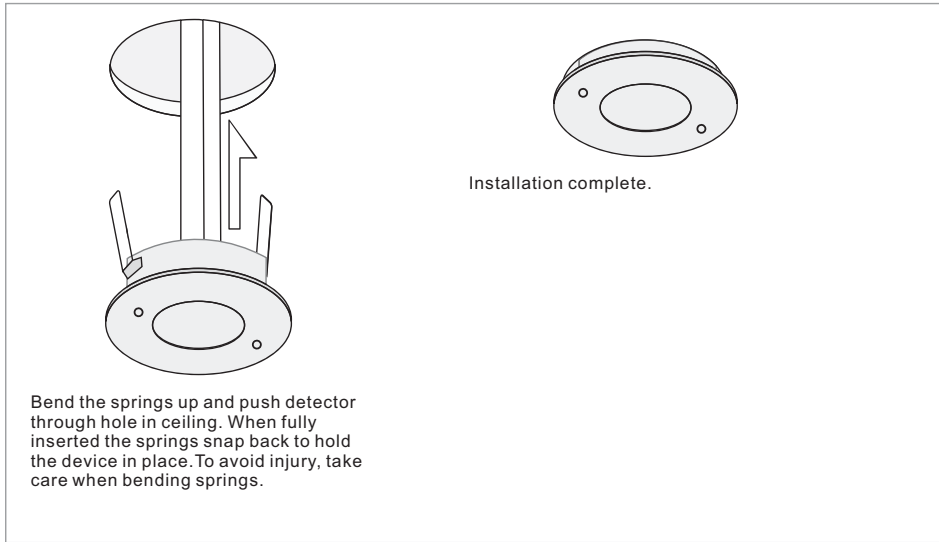

Product Dimension

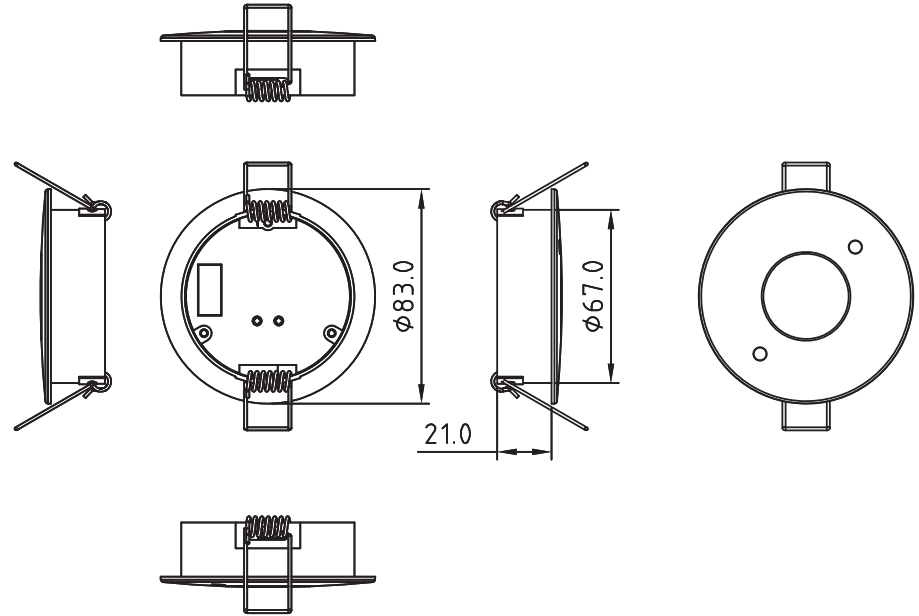

Wiring Diagram

